

QUICK GUIDE

160XT II - 180XT II - 210XT II

160XTB II - 180XTB II - 210XTB II

NOTICE! This quick guide is a brief summary of the use of DINO access platform and does not replace the operating instructions for the device.

Read the operating instructions and make sure that you understand all of the instructions and warnings before using the device.

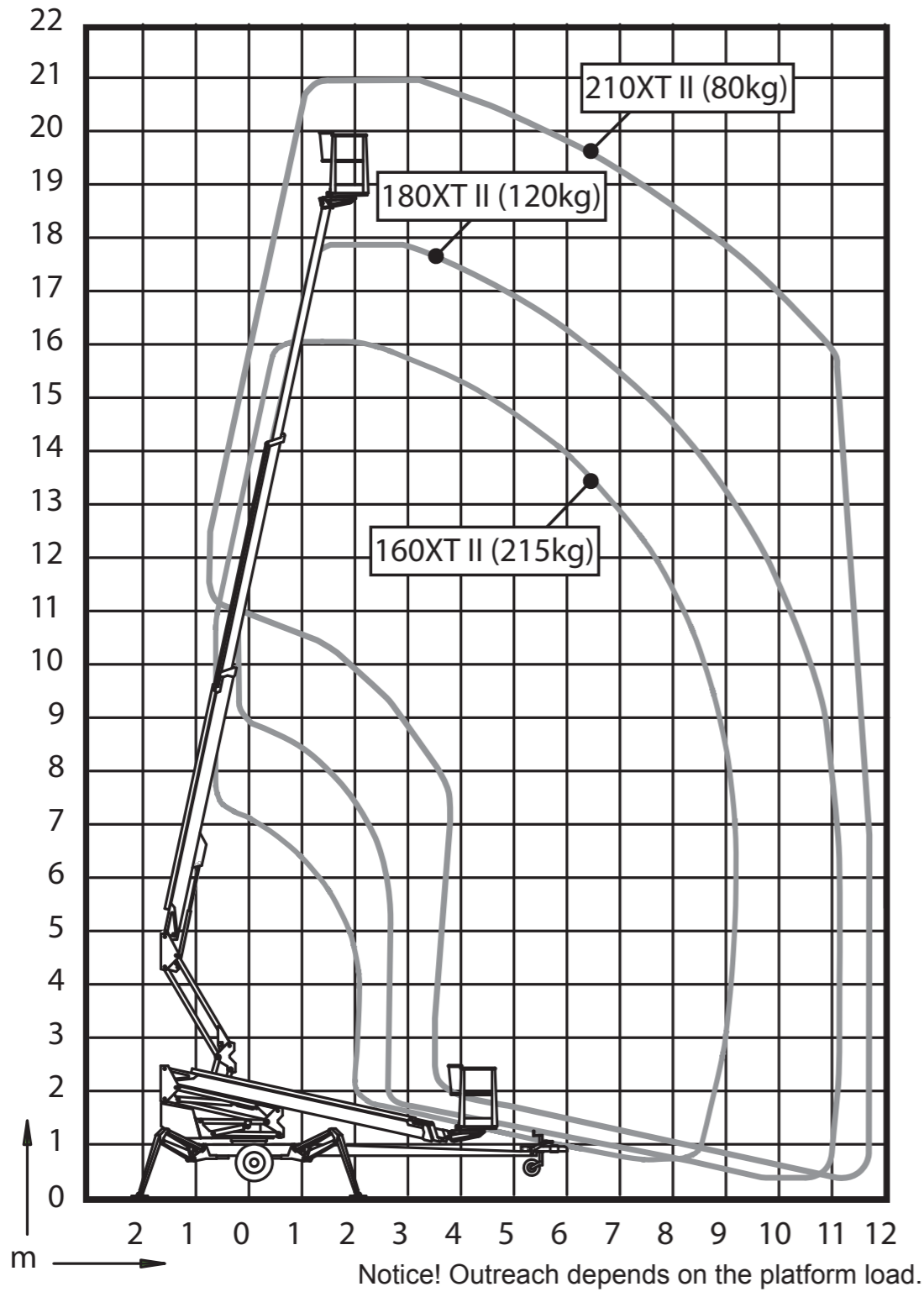

	160XT II	160XTB II	180XT II	180XTB II	210XT II	210XTB II
Weight	1990 kg	2175 kg	2300 kg	2390 kg	2465 kg	2590 kg
Transport height	2,30 m		2,30 m		2,33 m	
Transport width	1,80 m		1,95 m		1,95 m	
Support width	3,9 / 4,2 m		3,9 / 4,3 m		3,9 / 4,3 m	
Lifting capacity	215 kg		215 kg		215 kg	

LIFT FUNCTIONS

Boom rotation: continuous
Basket rotation: 180°

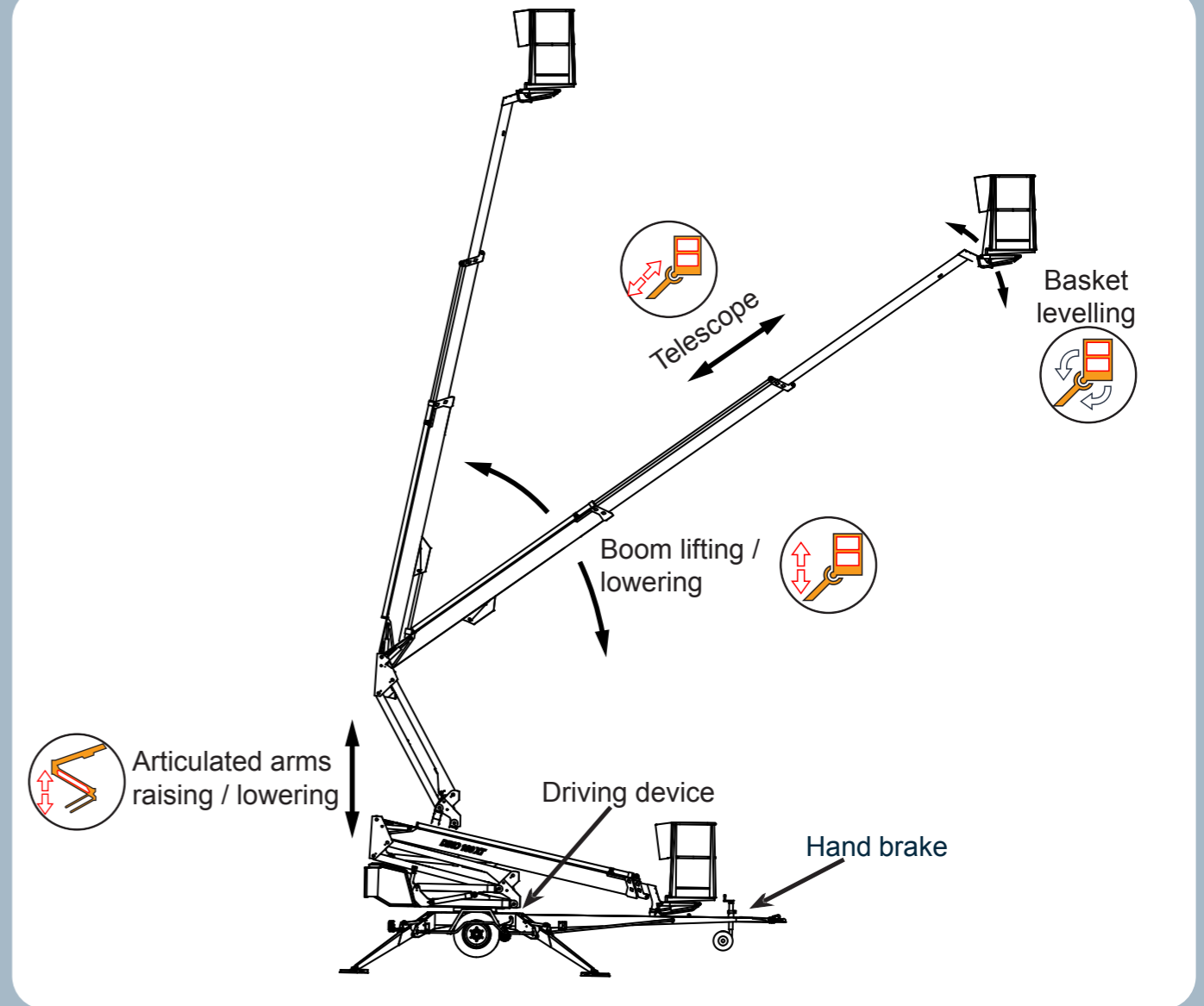
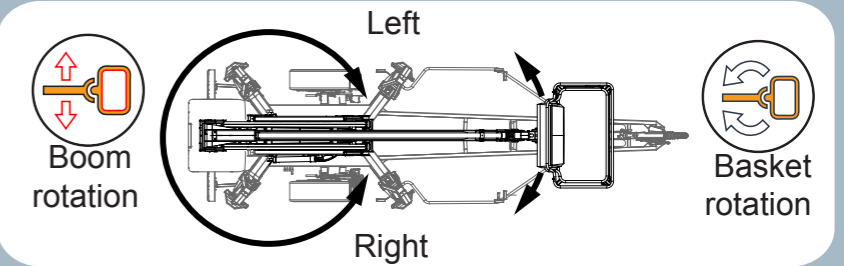

DAILY INSPECTIONS

- Check the condition of the work platform, boom and chassis structures
- Check the air pressure in the tyres and signs of damage
- Check the operation and condition of the lights
- Check hydraulic oil level and the condition of hydraulic hoses, pipes and fittings
- Check the safety limits function
- Check the emergency descent, emergency stop and sound signal
- Check that all adhesive tapes and plates are in place, intact and legible
- Check that the lift includes operating instructions and that they are legible.



SCAN CODE AND SEE QUICK START -VIDEO

(180XT II)

WORK SAFELY



Controls for safety devices:

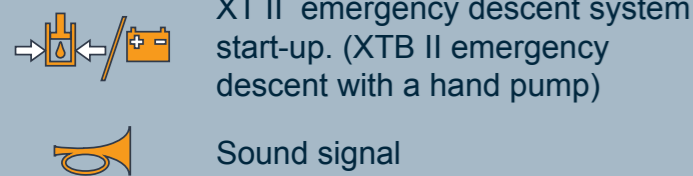

- This quick guide does not replace the operating instructions. Read the operating instructions before using the lift
- The lift operator must be over 18 years old
- The use of a faulty lift is strictly forbidden
- The use of the lift is forbidden if the temperature is below -20°C and/or the wind speed over 12,5 m/s
- The lift must not be used as a crane
- Make sure the work area is free
- The maximum permissible load must not be exceeded
- Never add load while in the upper position
- Maximum permitted lateral force load of 400 N

ALTERNATIVE POWER SOURCES



Battery Mains power Petrol engine Diesel engine



Choke



Engine start / stop

Please note information related to power sources:

- The aggregate does not start if the lift is connected to the mains
- Maximum cable length in mains network 25 meters (2,5mm² cable), fuse 10 A.
- Make sure that the batteries have time to charge sufficiently with aggregate or mains power.
- If the engine does not start, make sure that none of the emergency stop buttons has been pressed down.

TOWING AND USING THE DRIVING DEVICE WITH THE LIFT IN THE TRANSPORT POSITION

The lift may only be moved in the transport position

- The boom lowered on the boom support
- The cover of the platform control centre closed
- Outriggers fully up
- No objects on the platform or the chassis
- Make sure that the electrical cable is disconnected or the cable is long enough

Towing the lift

- Connect the ball-coupling and cable
- Connect the power line and check the lights
- Release the parking brake
- Lift up the jockey wheel
- Make sure that the driving device is not connected

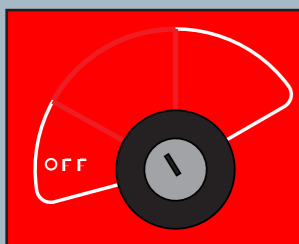

Driving with the driving device

- The selector switch must be set to "chassis control center"
- Switch the driving device to the driving position
- Release the hand brake
- Drive the lift with the drive controls
- Beware of obstacles and power lines

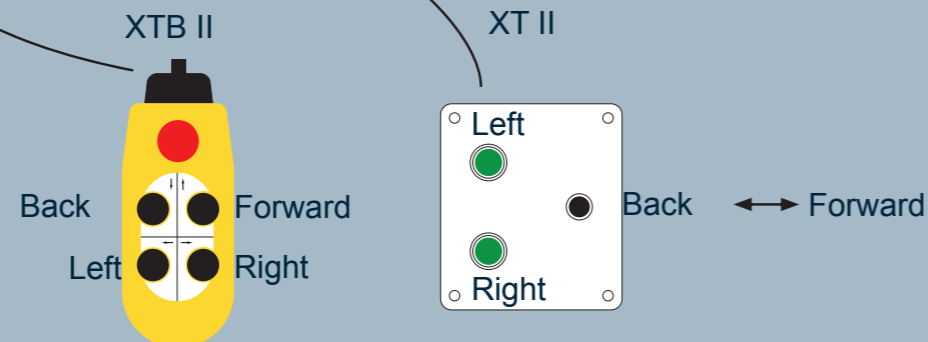
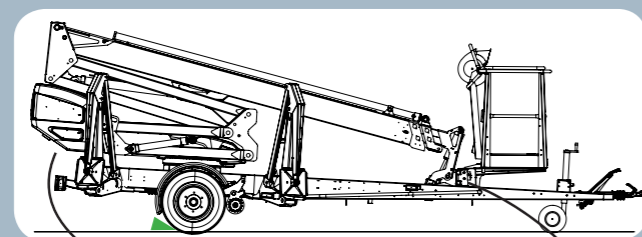

LIFT SUPPORT AND USE FROM THE CHASSIS CONTROL CENTRE

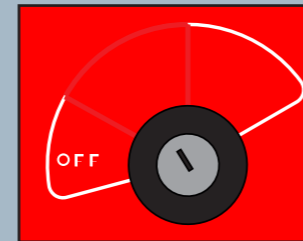

Indicator lights:

- The outrigger legs are supported and use of the boom is permitted.
- Overload or the load at the outreach range limit

Automatic leveling (optional):

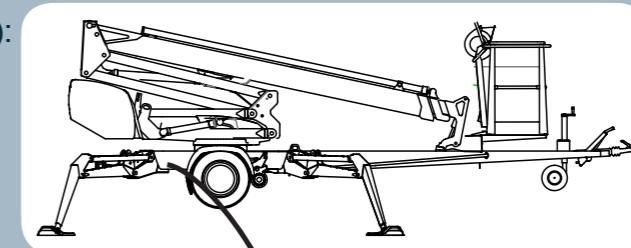
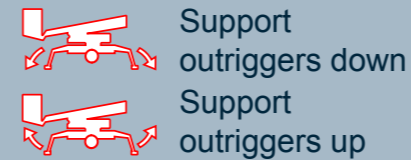

Max support force on the outriggers:

- 160XT II/XTB II: 16800 N (1700 kg)
- 180XT II/XTB II: 16800 N (1700 kg)
- 210XT II/XTB II: 22800 N (2300 kg)

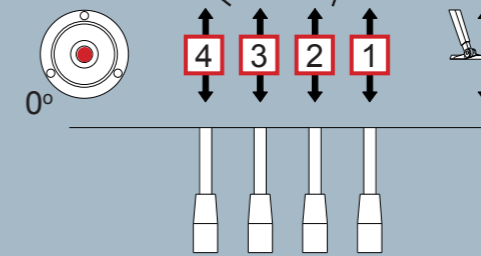

Positioning and levelling:

- Make sure the ground is even and sturdy enough. If necessary, use additional support plates.
- Lower the front support outriggers
- Lower the rear support outriggers
- Level the lift. The air bubble in the level gauge must be located inside the inner ring.
- Make sure that the tyres are properly off the ground

Boom movements can also be used from chassis control center after the outriggers are on the ground.

The battery operated models have two operating speeds for boom functions.



NOTICE! Support outriggers movements do not operate if the boom is not on the boom support.

OPERATING THE LIFT FROM PLATFORM CONTROL CENTRE

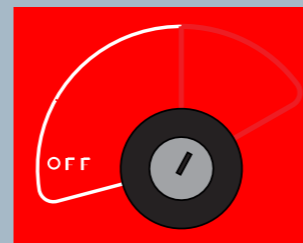

Indicator lights:

- The load is within outreach range.
- Overload or the load at the outreach range limit

The control panel symbols:

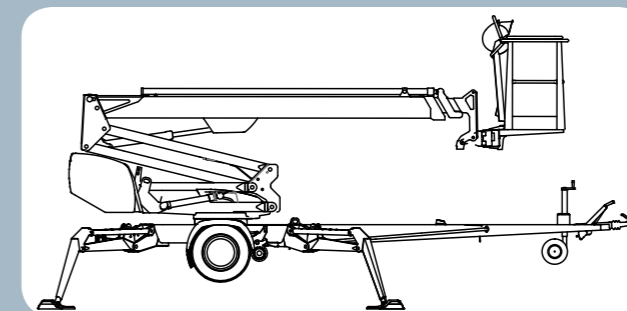
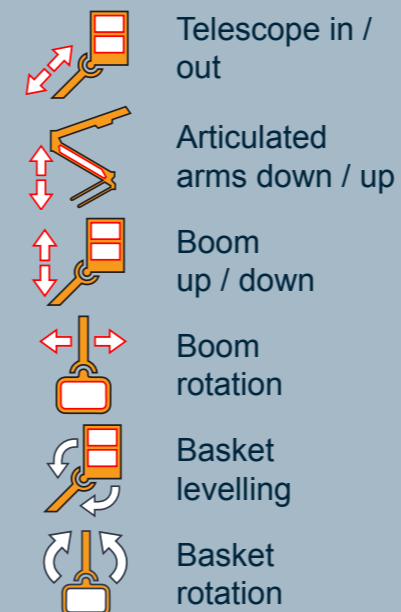

Before use

- Perform daily maintenance procedures
- Check that the lift is properly supported in a level position
- Check the emergency stop and the emergency descent system
- Check the work area

While in operation

- Monitor the danger area
- Beware of high-voltage power lines
- Do not climb onto the platform railing
- Do not drop objects from the platform
- If the overload indicator lights up, retract the telescope until the platform is back in working range.

NOTICE! The boom movements do not operate if the support outriggers are not firmly on the ground