



QUICK GUIDE

135TB - 150TB - 180TB

NOTICE! This quick guide is a brief summary of the use of DINO access platform and does not replace the operating instructions for the device.

Read the operating instructions and make sure that you understand all of the instructions and warnings before using the device.

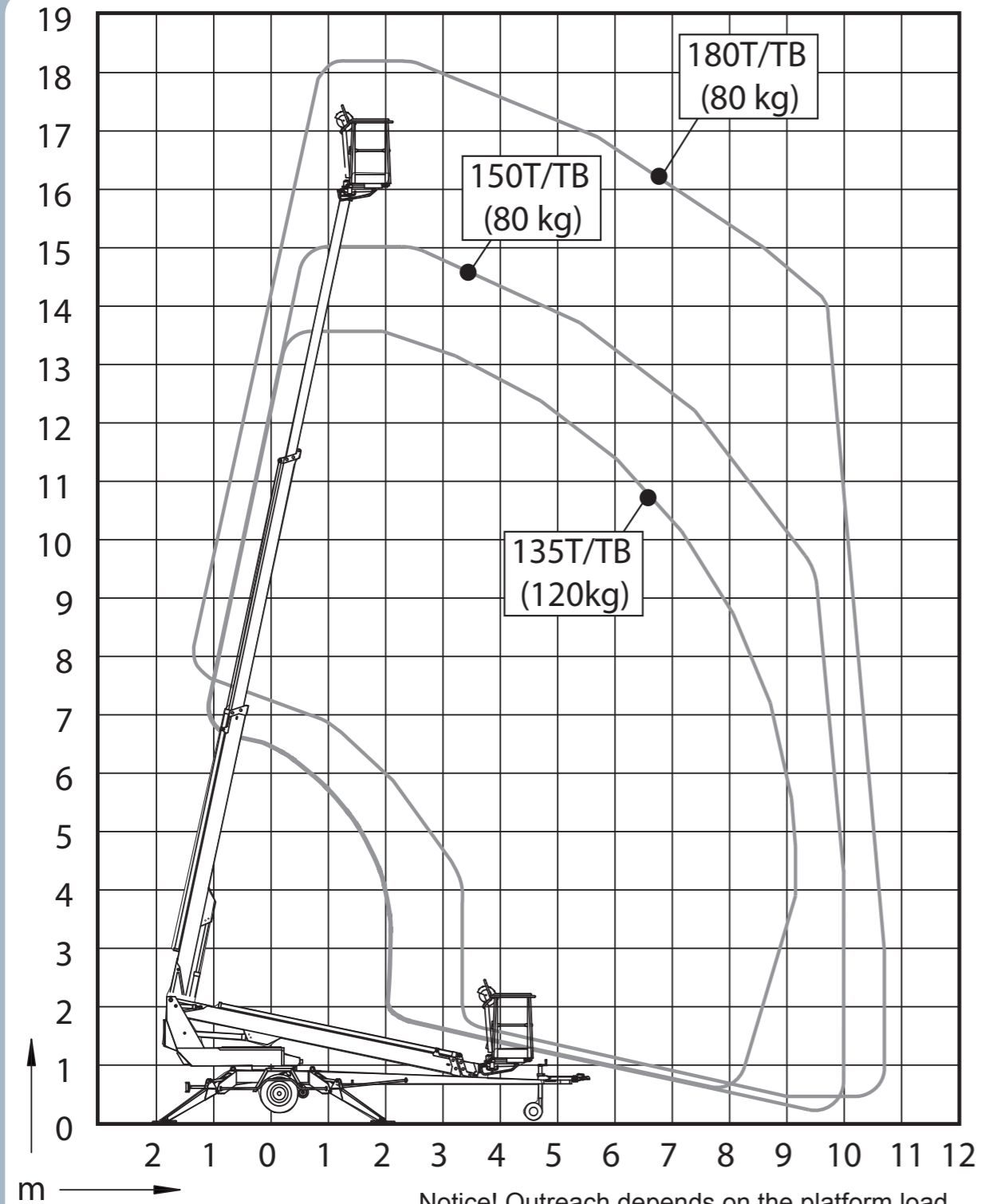

	135TB	150TB	180TB
Weight	1765 kg	1835 kg	1945 kg
Transport height	2,16 m	2,24 m	2,18 m
Transport width	1,78 m	1,78 m	1,78 m
Support width	3,8 / 4,2 m	3,8 / 4,2 m	3,8 / 4,2 m
Lifting capacity	215 kg	215 kg	215 kg

LIFT FUNCTIONS

Boom rotation: continuous
Basket rotation: 90°

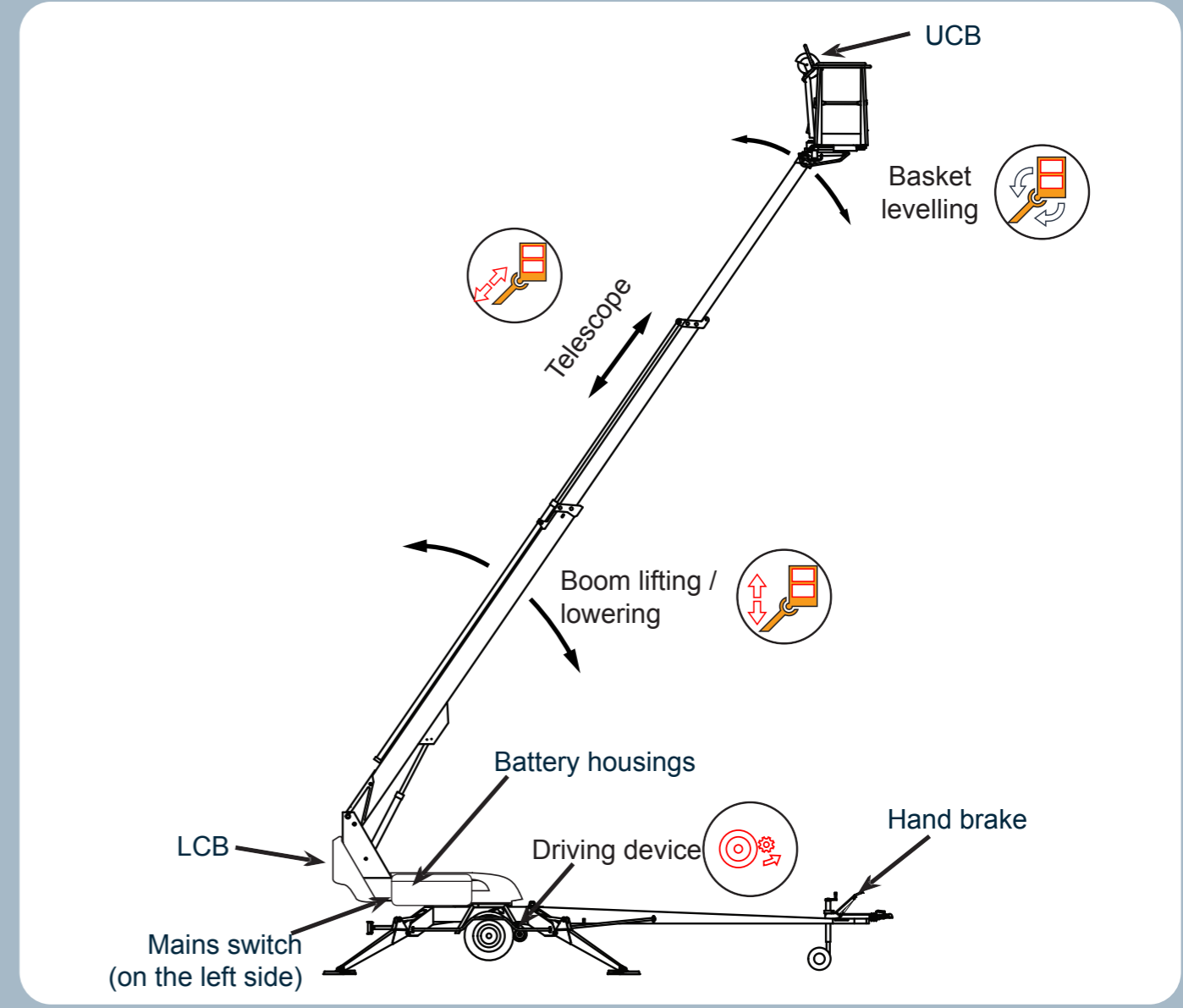
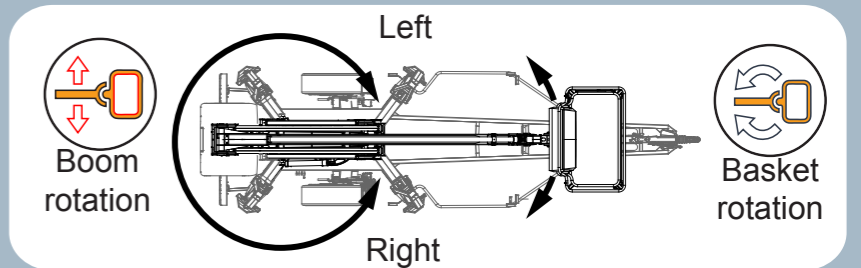



DAILY INSPECTIONS

- Check the condition of the work platform, boom and chassis structures
- Check the air pressure in the tyres and signs of damage
- Check the operation and condition of the lights
- Check hydraulic oil level and the condition of hydraulic hoses, pipes and fittings
- Check the safety limits function
- Check the emergency descent, emergency stop and sound signal
- Check that all adhesive tapes and plates are in place, intact and legible
- Check that the lift includes operating instructions and that they are legible.

WORK SAFELY



Safety functions:





-  Sound signal (UCB)
-  Emergency stop (UCB + LCB)
-  Emergency descent with a hand pump and manually operated valve (LCB)

- This quick guide does not replace the operating instructions. Read the operating instructions before using the lift
- The lift operator must be over 18 years old
- The use of a faulty lift is strictly forbidden
- The use of the lift is forbidden if the temperature is below -20°C and/or the wind speed over 12,5 m/s
- The lift must not be used as a crane
- Make sure the work area is free
- The maximum permissible load must not be exceeded
- Never add load while in the upper position
- Maximum permitted lateral force load of 400 N

POWER SOURCE

	Electric motor	3 kW, 24VDC
	Batteries	4 x 6V, 235 Ah
	Charging	Mains current
		Petrol engine

Battery gauge indicator lights

-  operating hours
-  ON: battery charge %
-  Flashes: battery charge is below 10%
-  Flashes: error code

NOTICE!

- Charge batteries at the end of the day. Keeping the batteries discharged shortens their service life.
- Empty batteries freeze more easily
- Battery capacity is affected by operating temperature.
- If the engine does not start, make sure that none of the emergency stop buttons has been pressed down.



WARNING!

- The electrolyte is very corrosive!
- The battery generates hydrogen gas during charging. Explosion hazard!

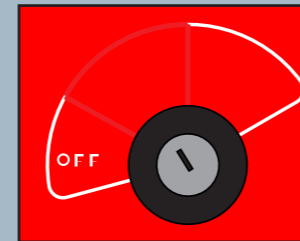
LIFT SUPPORT AND USE FROM THE CHASSIS CONTROL CENTRE



Indicator lights:

-  The outrigger legs are supported and use of the boom is permitted.
-  Overload or the load at the outreach range limit

Max support force on the outriggers:

- 135TB: 11300 N (1150 kg)
- 150TB: 12800 N (1300 kg)
- 180TB: 16800 N (1700 kg)

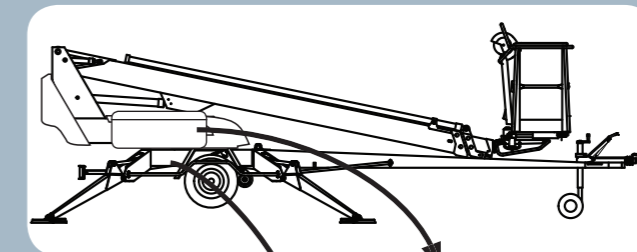

 Start button for outrigger operation

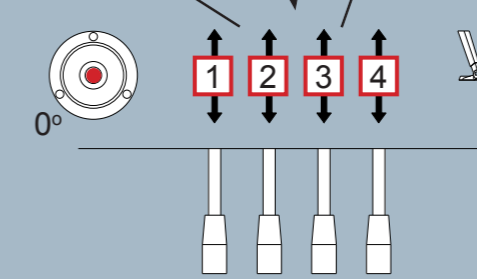

Boom movements can also be used from chassis control center after the outriggers are on the ground.

-  Speed selector switch for boom operation and driving device (hold-to-run)

NOTICE! Support outriggers movements do not operate if the boom is not on the boom support.

TOWING AND USING THE DRIVING DEVICE WITH THE LIFT IN THE TRANSPORT POSITION

The lift may only be moved in the transport position

- The boom lowered on the boom support
- The cover of the platform control centre closed
- Outriggers fully up
- No objects on the platform or the chassis
- Make sure that the electrical cable is disconnected or the cable is long enough

Towing the lift

- Connect the ball-coupling and cable
- Connect the power line and check the lights
- Release the parking brake
- Lift up the jockey wheel
- Make sure that the driving device is not connected

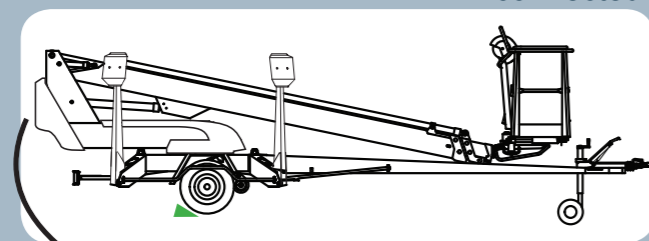
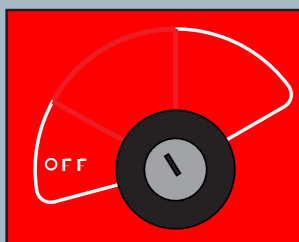

Driving with the driving device

- The selector switch must be set to "chassis control center"
- Switch the driving device to the driving position
- Release the hand brake
- Drive the lift with the drive controls
- Beware of obstacles and power lines

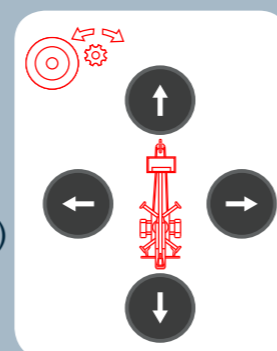

-  Speed selector switch for boom operation and driving device (hold-to-run)



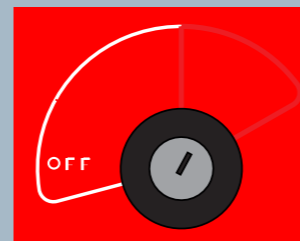





OPERATING THE LIFT FROM PLATFORM CONTROL CENTRE



Indicator lights:

-  The load is within outreach range.
-  Overload or the load at the outreach range limit

The control panel symbols:

-  Telescope in / out
-  Boom up / down
-  Boom rotation
-  Basket levelling
-  Basket rotation
-  Fuse (basket rotation)

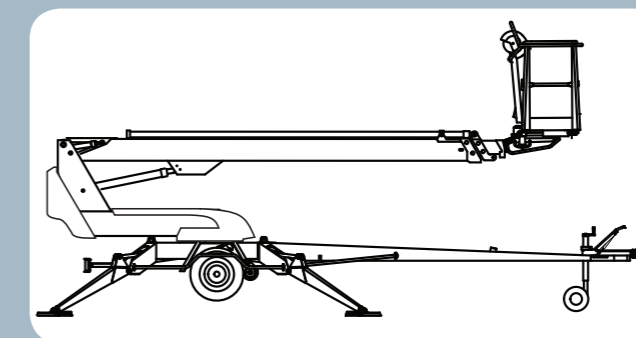

Before use

- Perform daily maintenance procedures
- Check that the lift is properly supported in a level position
- Check the emergency stop and the emergency descent system
- Check the work area

While in operation

- Monitor the danger area
- Beware of high-voltage power lines
- Do not climb onto the platform railing
- Do not drop objects from the platform
- If the overload indicator lights up, retract the telescope until the platform is back in working range.

NOTICE! The boom movements do not operate if the support outriggers are not firmly on the ground