

Meet

DINO 160XT II

DINO® TRAILER MOUNTED MEWPs

Standard features in DINO 160XT II:

- Maximum outreach with full basket load
- Compact size, transport length only 6.15 m
- Total weight less than 2000 kg including engine
- Driving system; easy to move at work site with cable steering
- Hydraulic basket rotation 180°
- Spacious, easy-entry basket; capacity 215 kg
- Large outrigger pads 280 x 360 mm
- Continuous rotation of the boom; easy and functional
- Stable to tow
- Simple to use, clear and informative controls



Options available for DINO 160XT II:

- Petrol or diesel power engine
- Two joystick controls
- Outrigger support indicator
- Automatic levelling
- LED working lights
- Extra outrigger pads 500 x 500 x 35 mm + bracket
- Lockable tool / harness box
- Rack for tools and accessories
- Spare wheel
- DINO SafeGuard secondary guarding
- DINO SkyRack – plate & tube rack max loading 100 kg, 3 m²

Technical data

	160XT II
Max. working height	16.00 m
Max. platform height	14.00 m
Max. outreach	9.10 m
Support width	3.8 / 4.2 m
Lifting capacity	215 kg
Basket size	0.7 x 1.3 m
Boom rotation	cont.
Basket rotation	180°
Boom control	proport.
Transport length	6.15 m
Transport width	1.80 m
Transport height	2.30 m
Weight	1990 kg
Driving system	std
AC socket in the basket x 2	std
Electric motor 110/230 VAC	std
Petrol power engine	opt.
Diesel power engine	opt.
Gradeability	25 %

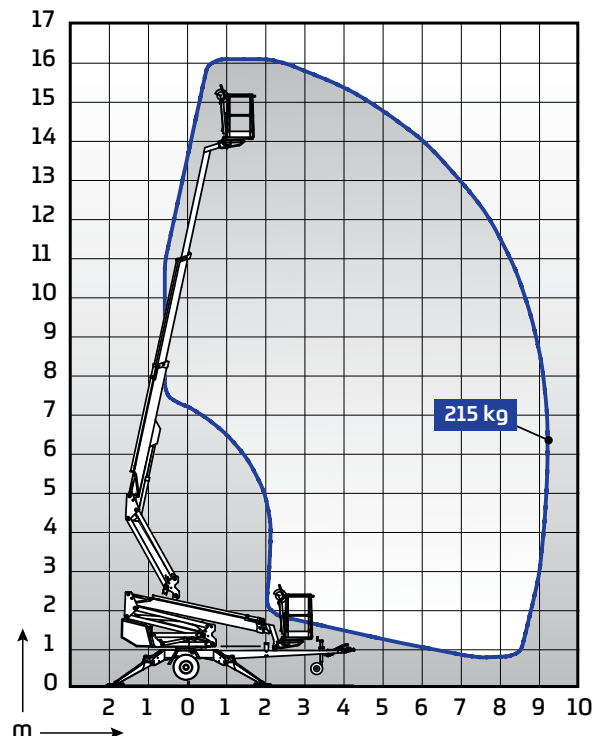

DINOLIFT

UP TO THE JOB

Dinolift Oy | Raikkolantie 145 • FI-32210 LOIMAA, FINLAND

Tel: +358 (0)20 1772 400 • E-mail: info@dinolift.com

www.dinolift.com

Technical specifications are subject to change without prior notice.

©Dinolift Oy | 25.10.23